



LADONTAMALLIT

LAKAN BETONI OY

1:10

LADONTAESIMERKKEJÄ

3.1.2025

KATULANKKU 80

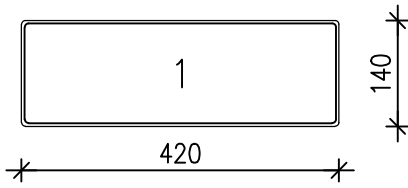

KATULANKKU 80

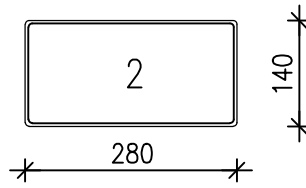

KATUKIVI 80

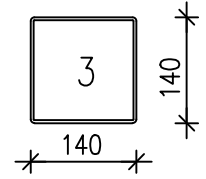

NUPUKIVI 80

1 / 2 KIVEN LIMITYKSELLÄ REUNOIHIN LEIKATAAN PUOLIKKAAT KATULANKKUT

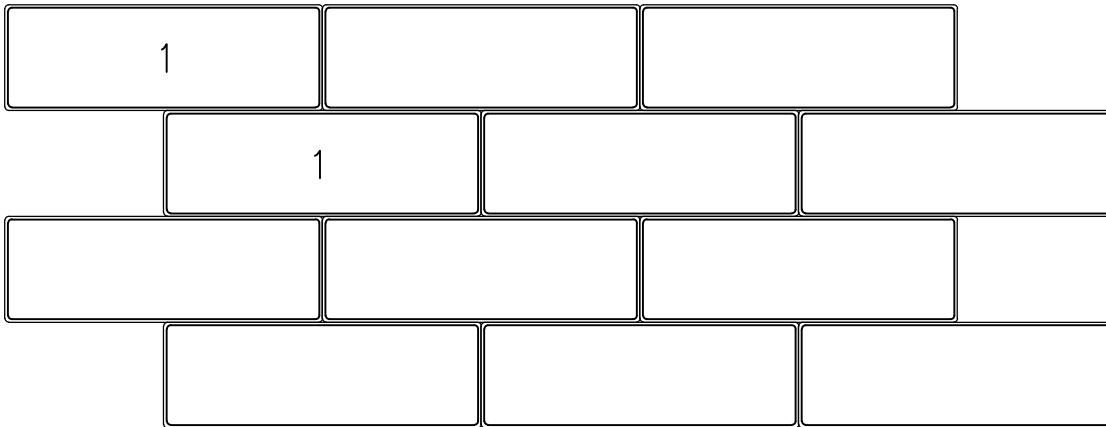

KALANRUOTOLADONNASSA REUNOJEN TASAUKSESSA KATUKIVI 80 JA NUPUKIVI 80

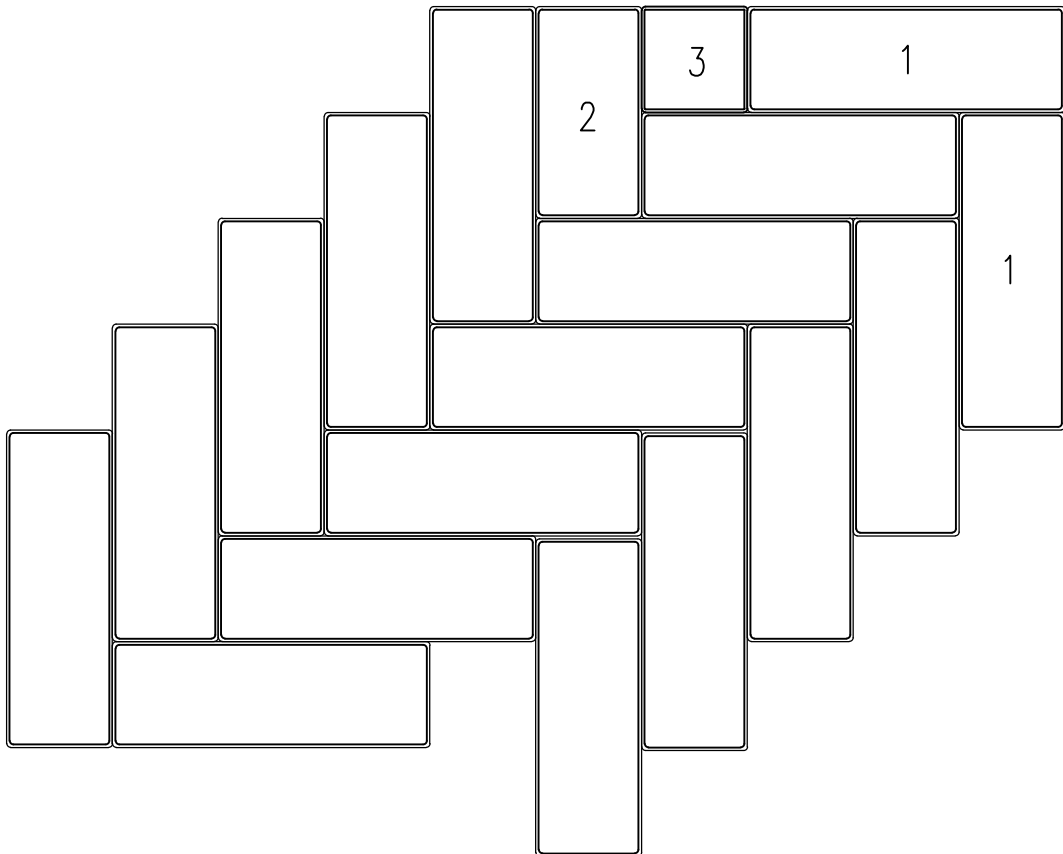



LADONTAMALLIT

LAKAN BETONI OY

1:10

LADONTAESIMERKKEJÄ

3.1.2025

KATULANKKU 80

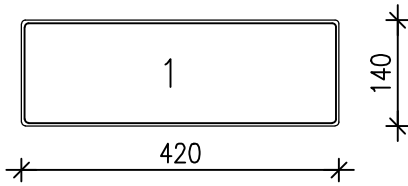

KATULANKKU 80

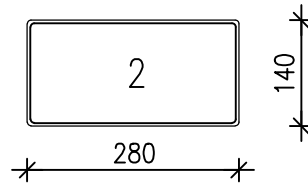

KATUKIVI 80

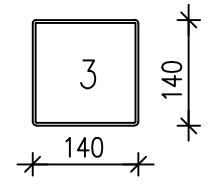

NUUKIVI 80

1 / 3 KIVEN LIMITYKSELLÄ REUNOIHIN NUUKIVI 80 JA KATUKIVI 80

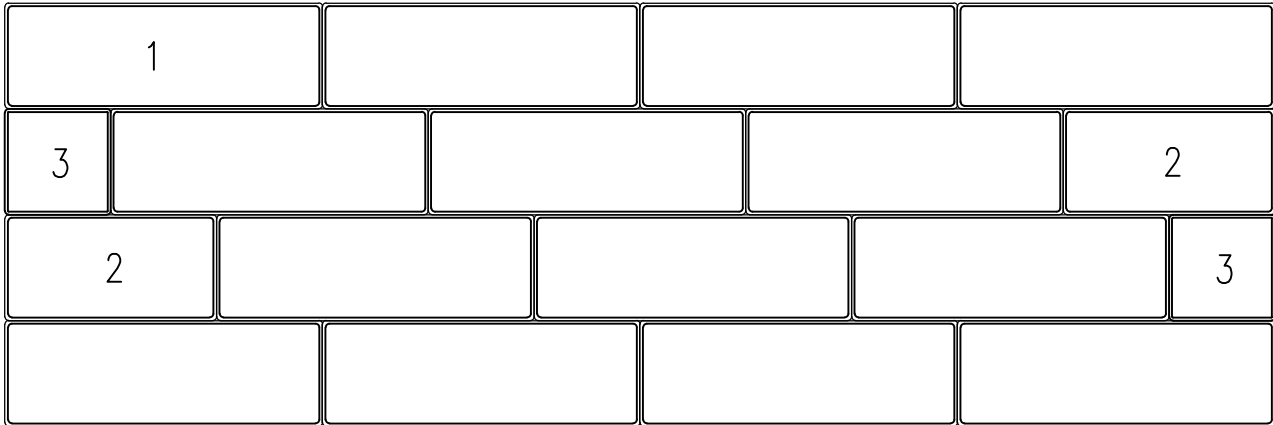

ROOMALAISET KIVET 208x208x80 JA 418x418x80 RIVILADONTA

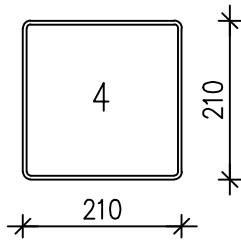

ROOMALAINEN KIVI  
208x208x80

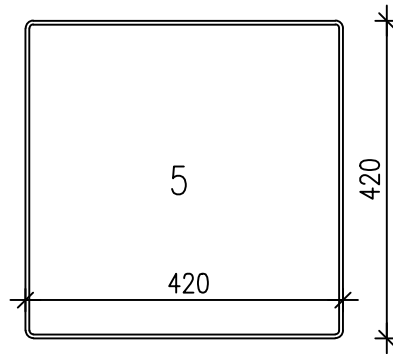

ROOMALAINEN KIVI  
408x408x80

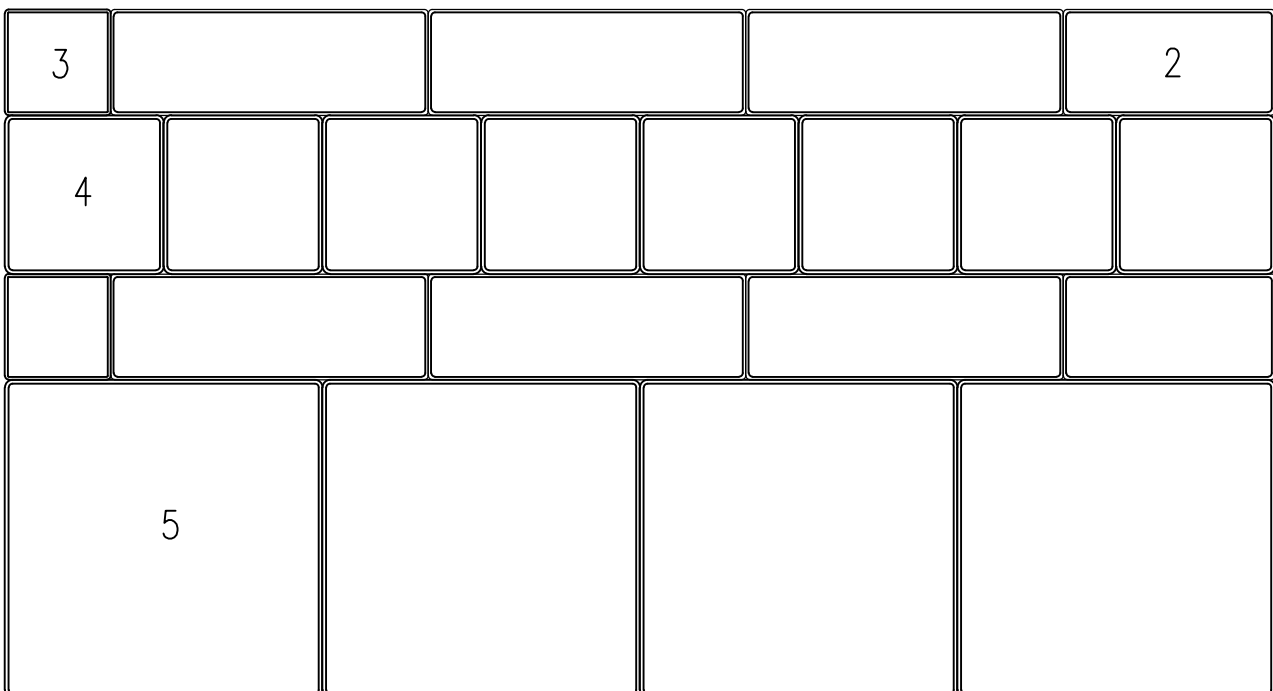



LADONTAMALLIT

LAKAN BETONI OY

1:10

LADONTAESIMERKKEJÄ

3.1.2025

HULEKATUKIVI 80 / KATULANKKU 80

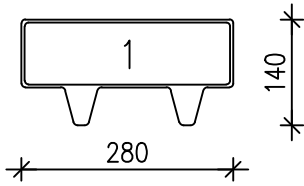

HULEKATUKIVI 80

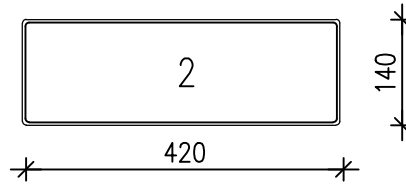

KATULANKKU 80

1 / 2 KIVEN LIMITYKSELLÄ REUNOIHIN LEIKATAAN PUOLIKKAAT KATULANKUT

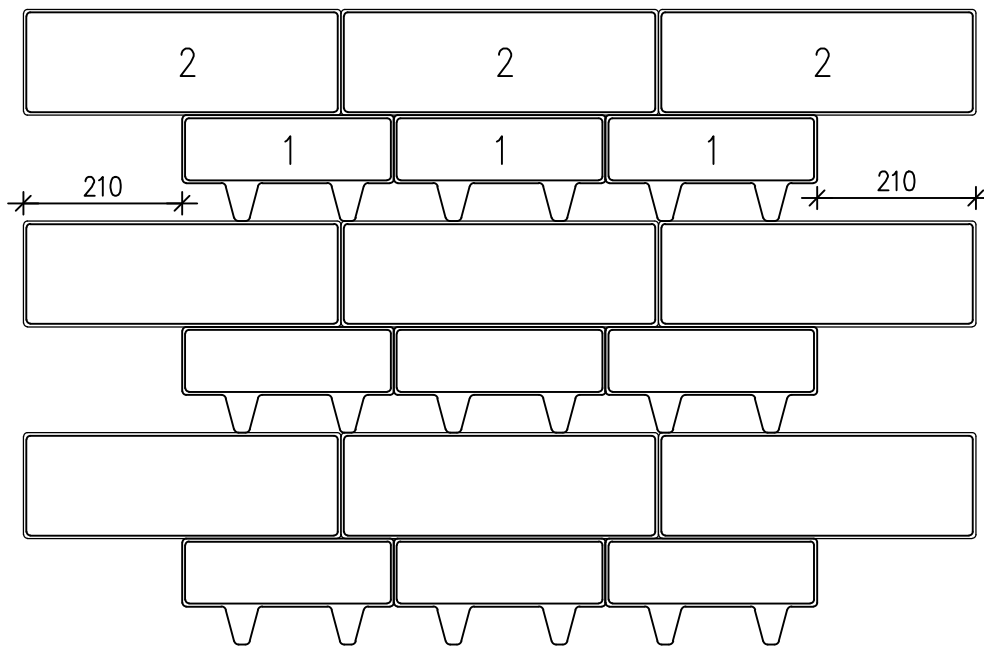



LADONTAMALLIT

LAKAN BETONI OY

1:15

LADONTAESIMERKKEJÄ

3.1.2025

PIHAKIVI+NUPUKIVI 60/KATUKIVI+NUPUKIVI 80

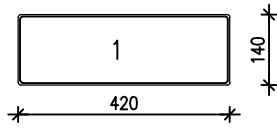

KATULANKKU 80

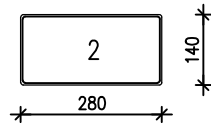

KATUKIVI 80

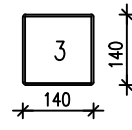

NUPUKIVI 80

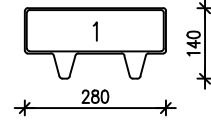

HULEKATUKIVI 80

1 / 3 KIVEN LIMITYKSELLÄ REUNOIHIN NUPUKIVI 80 JA KATUKIVI 80

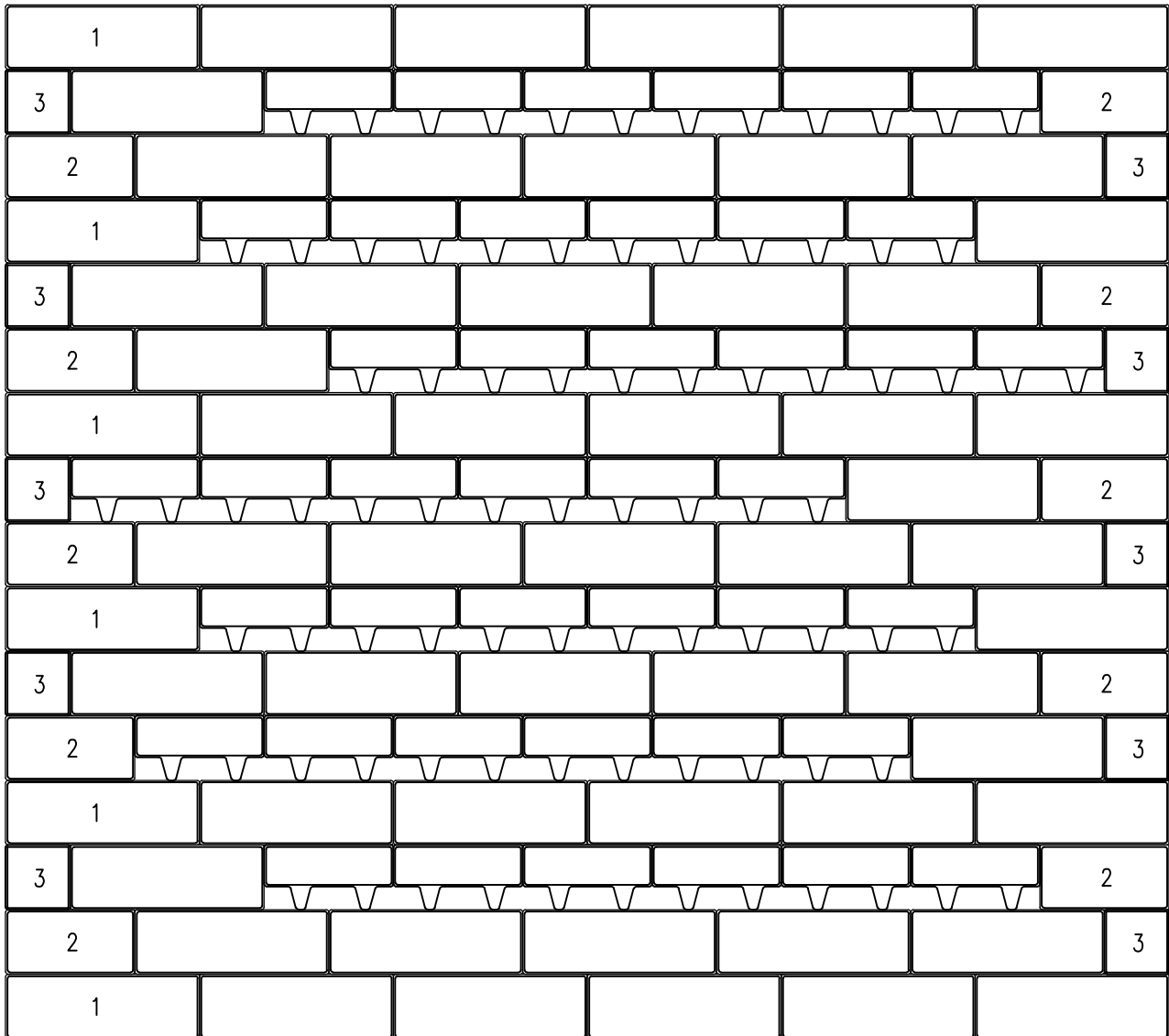

2520