

LOHKOKANSIKIVI

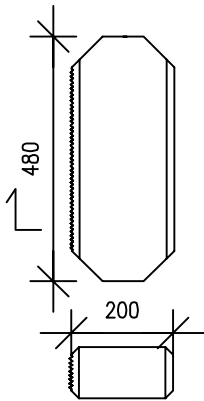

LOHKOMUURIKIVI

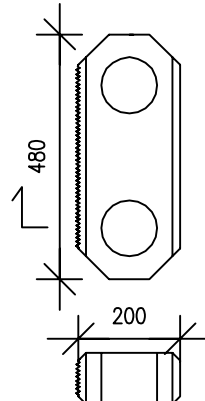

LOHKOMUURIKIVIPARI
Menekki 17,8 kiviparia/m2

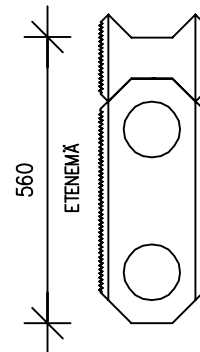

PÄÄTYKIVI "MUTTERI"

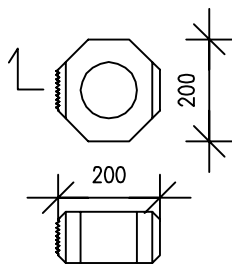

VÄLIKIVI "PERHONEN"

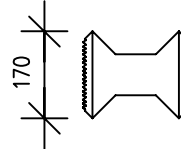

LOHKOMUURIKIVI- JA PÄÄTYKIVIPARI

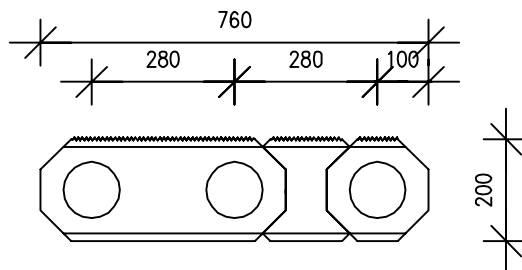

LOHKOMUURIKIVI ON VALMIIKSI LOHKAISTU.

KIVEN TOINEN PUOLI ON SILEÄ, JOLLOIN KUMPIKIN PUOLI ON JULKISIVUKELPOINEN.

RAKENNE VOIDAAN RAUDOITTA PYSTYSUUNTAAN, JOLLOIN PYSTYREIÄT VALETAAN BETONILLA KORKEISSA SEINÄMISSÄ.

SUORAKULMA TEHDÄÄN
LEIKKAAMALLA VÄLIKIVESTÄ
YKSI SAKARA POIS

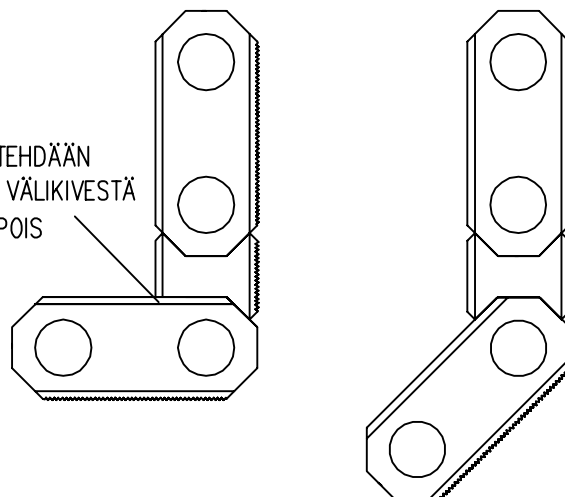



LADONTAMALLIT

LAKKA RAKENNUSTUOTTEET OY

1:50

LADONTAESIMERKKEJÄ

24.5.2016

LOHKOMUURIKIVI

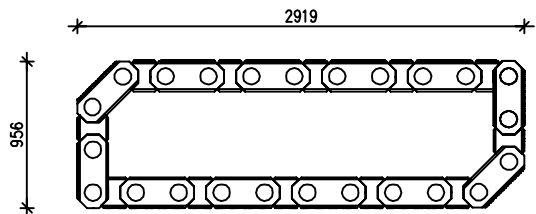
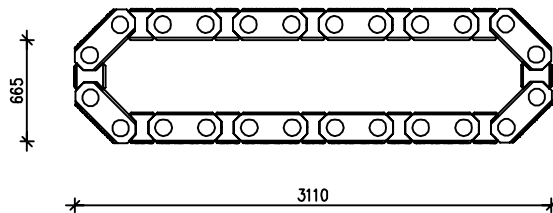
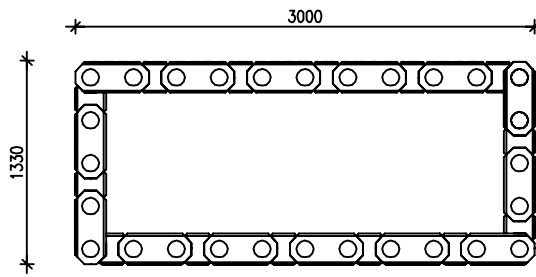
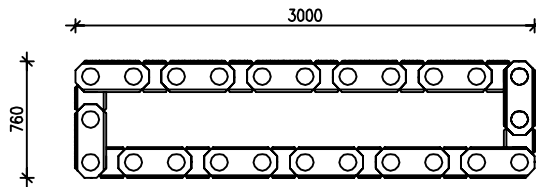

4 reikäkiviparia

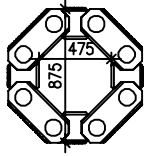

4 reikäkiviparia

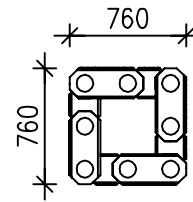

8 reikäkiviparia

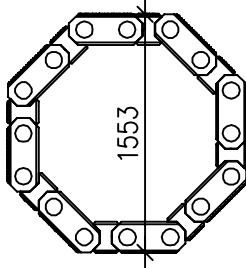

8 reikäkiviparia

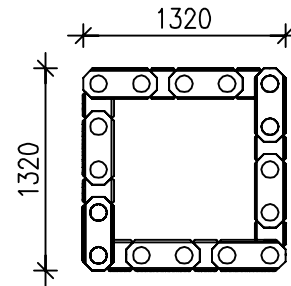

16 reikäkiviparia

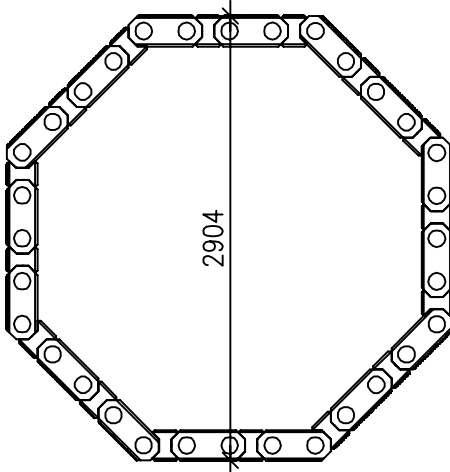

12 reikäkiviparia

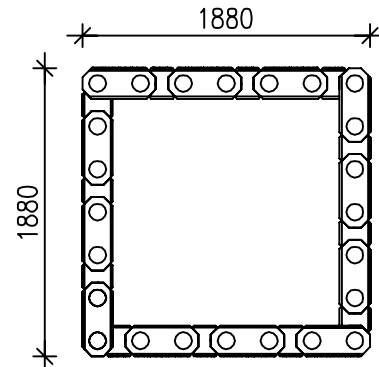

24 reikäkiviparia

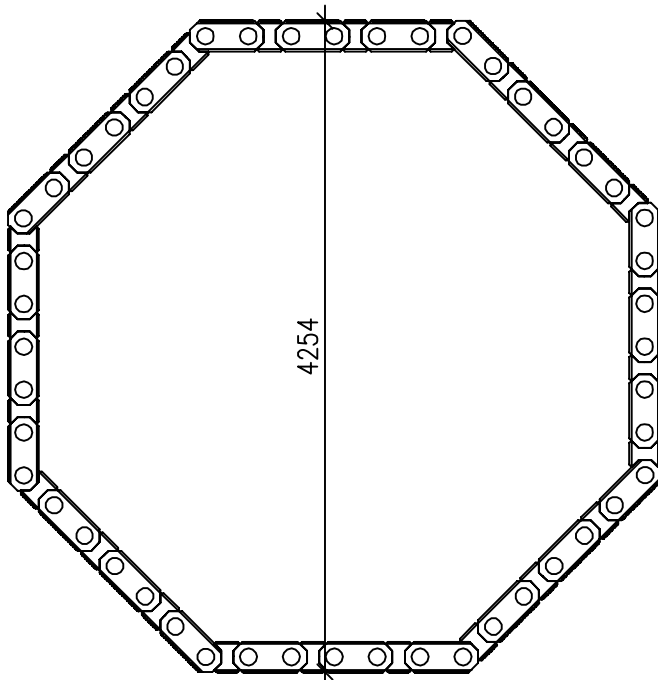

18 reikäkiviparia

