

1:25

1:75

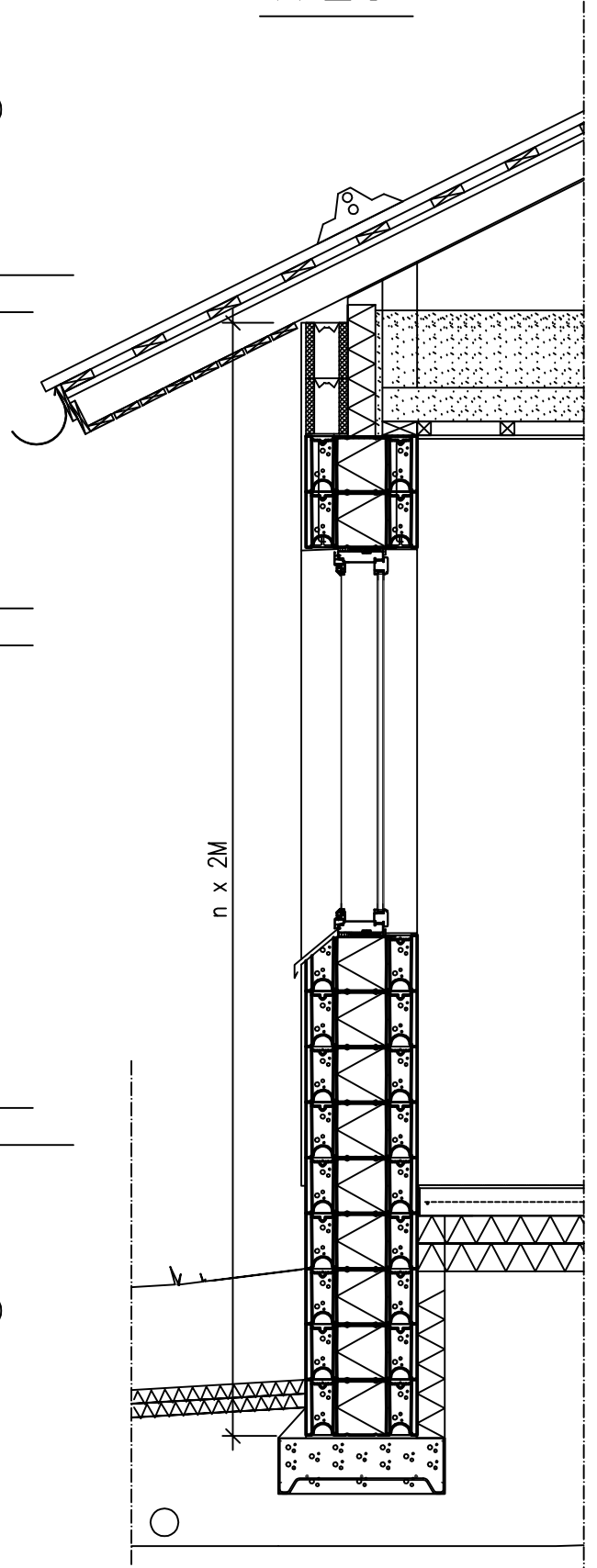
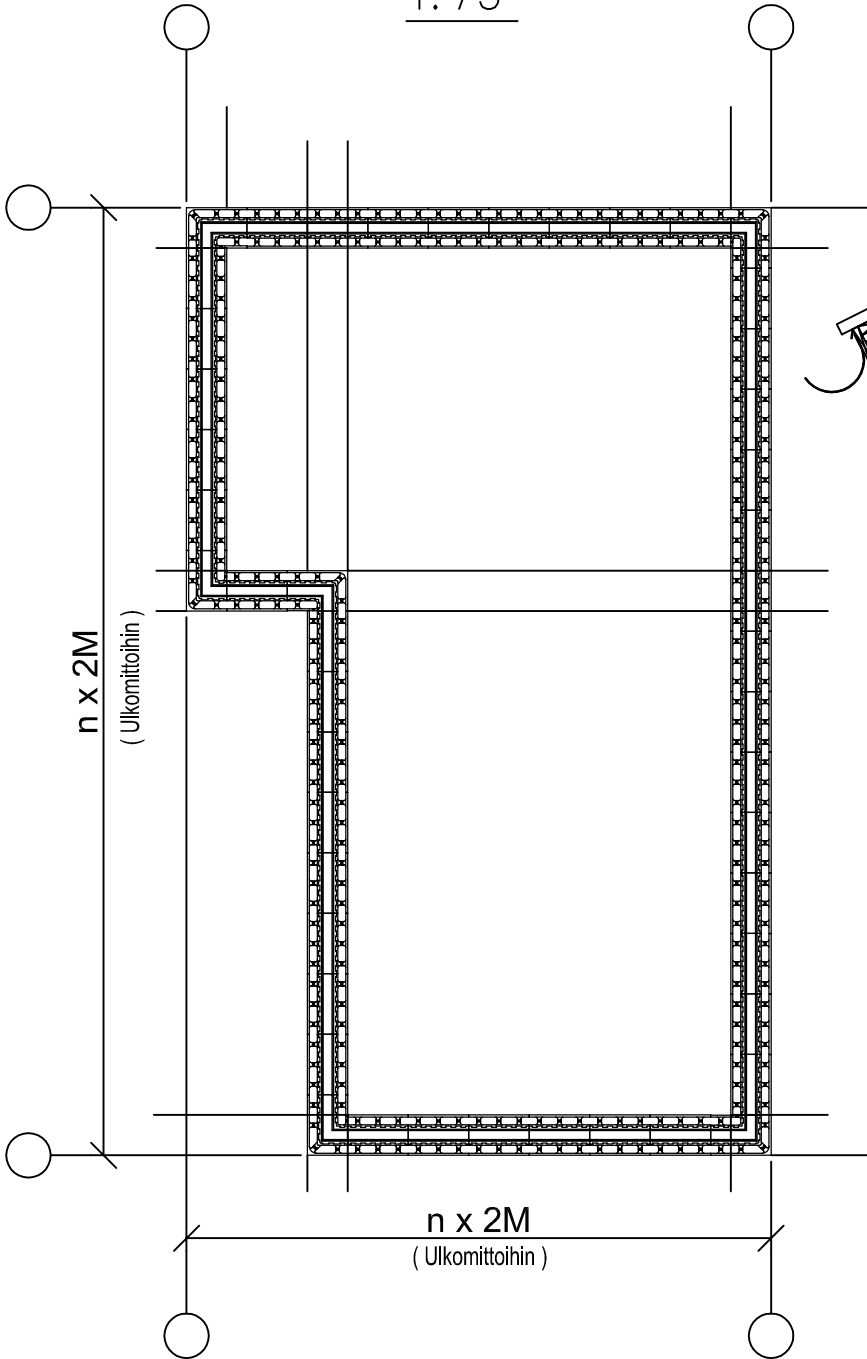

1:75

$n \times 2M$
(Sisämittöihin)

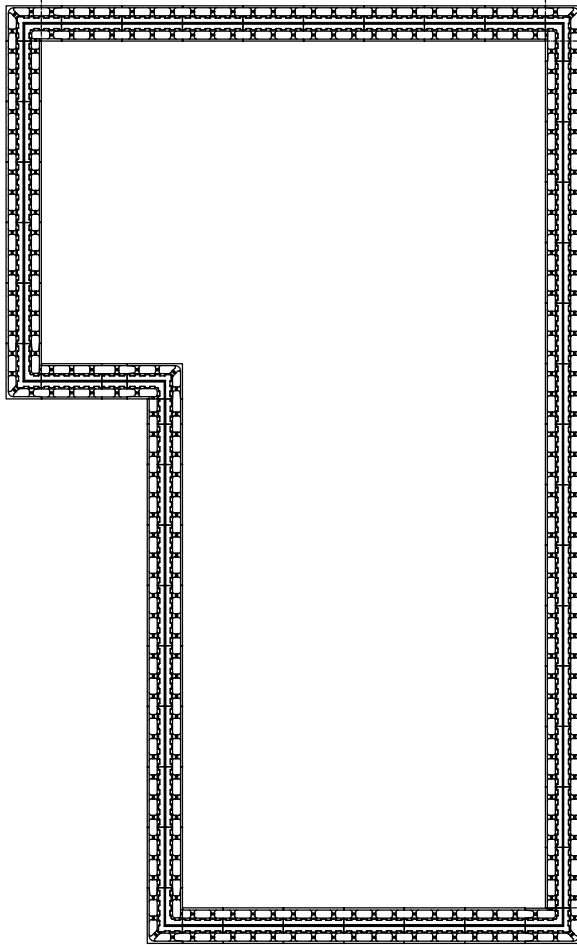

$n \times 2M$
(Sisämittöihin)

1:25

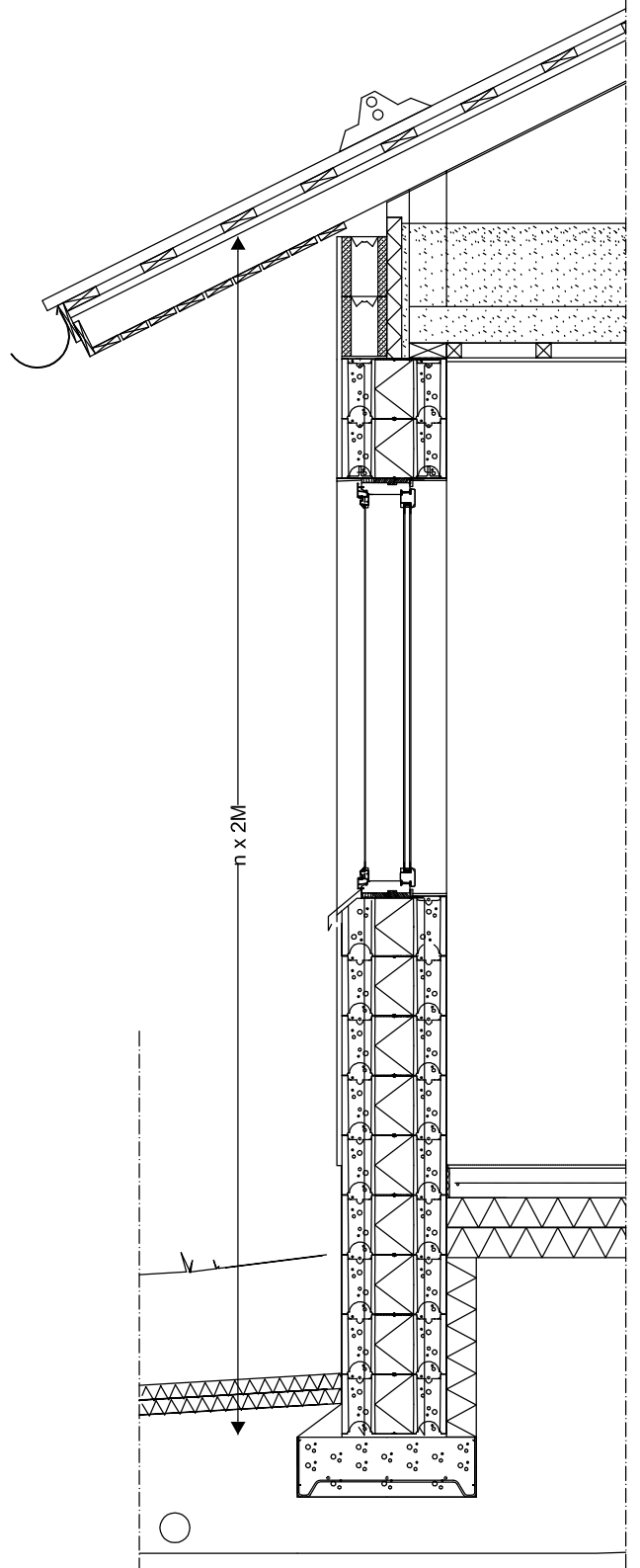

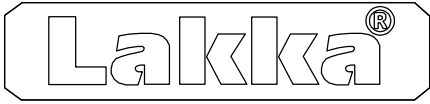

Muottiharkot, Ladonta

RAK, 1:50

LAKKA EMH-400PRO

11.10.2016

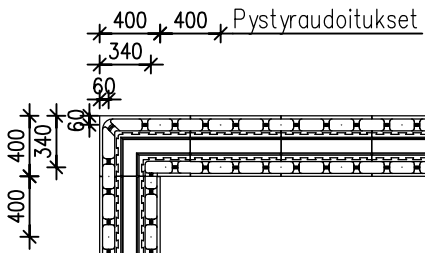

EMH-400PRO ERISTEMUOTTIHARKKOJEN LADONTA 1.KERROS

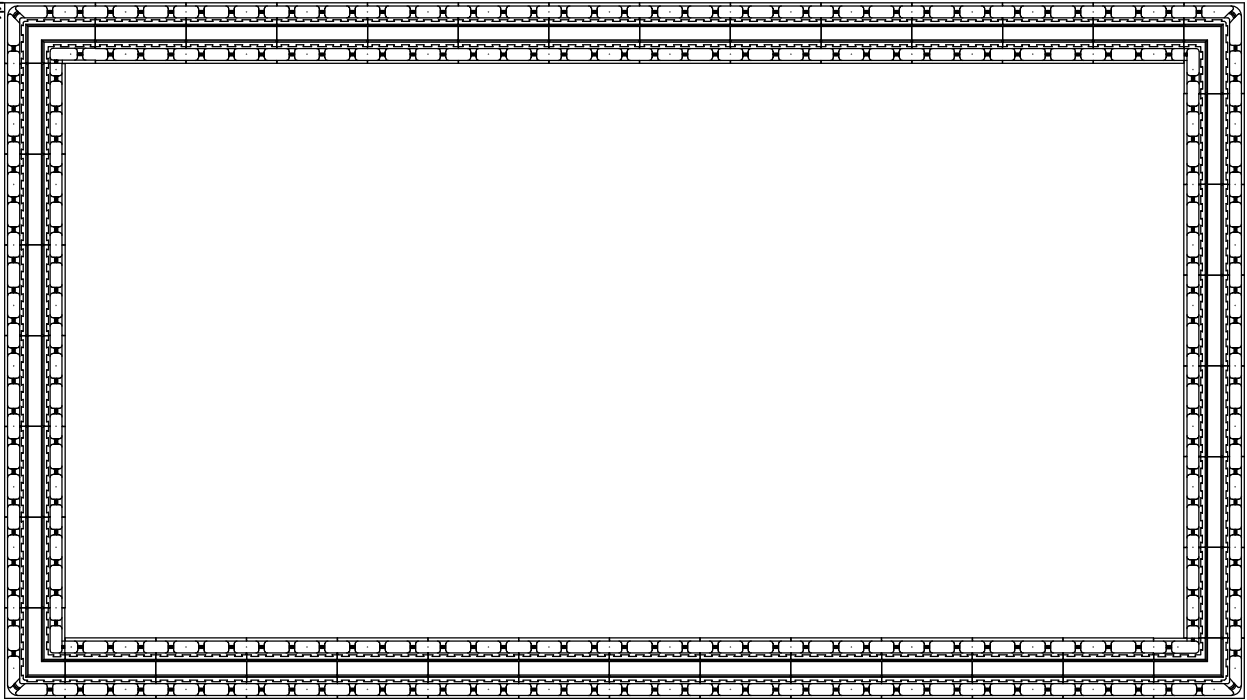

EMH-400PRO ERISTEMUOTTIHARKKOJEN LADONTA 2.KERROS

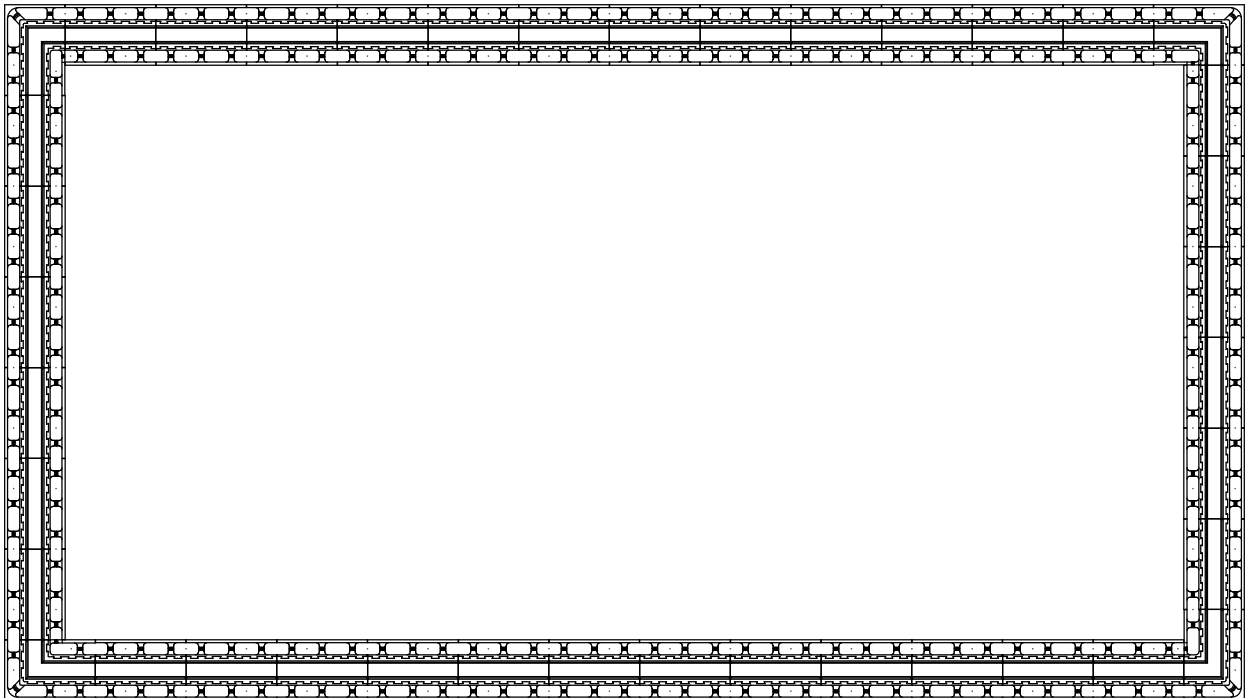

EMH-350PRO ERISTEMUOTTIHARKKOJEN LADONTA 1.KERROS

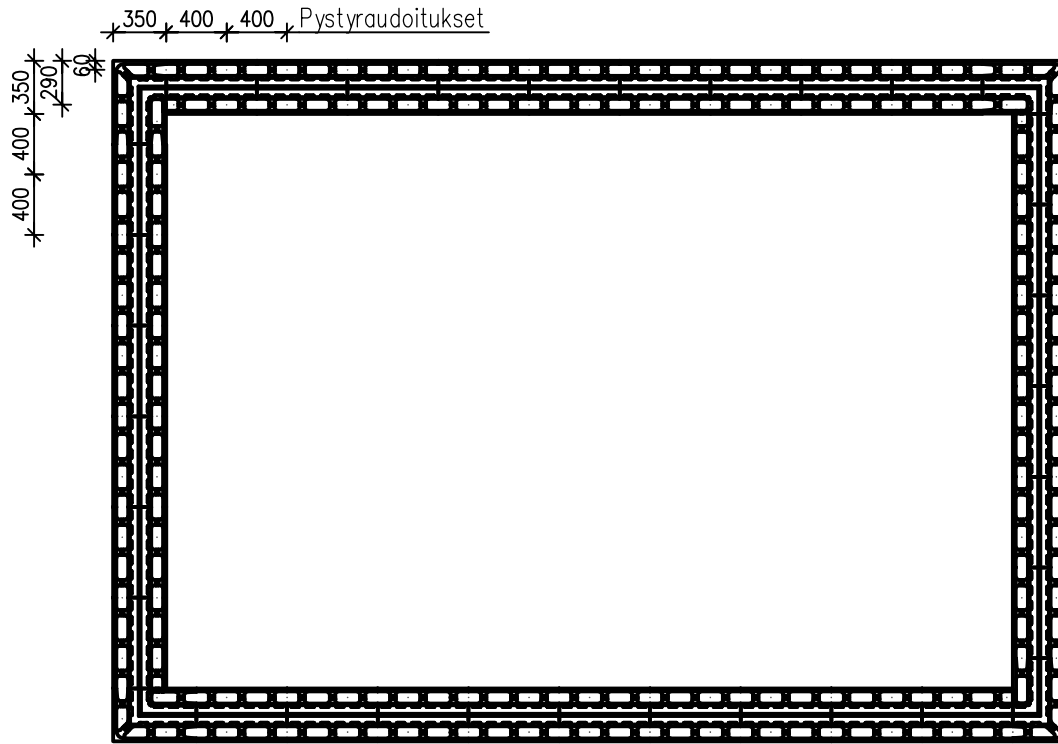

EMH-350PRO ERISTEMUOTTIHARKKOJEN LADONTA 2.KERROS

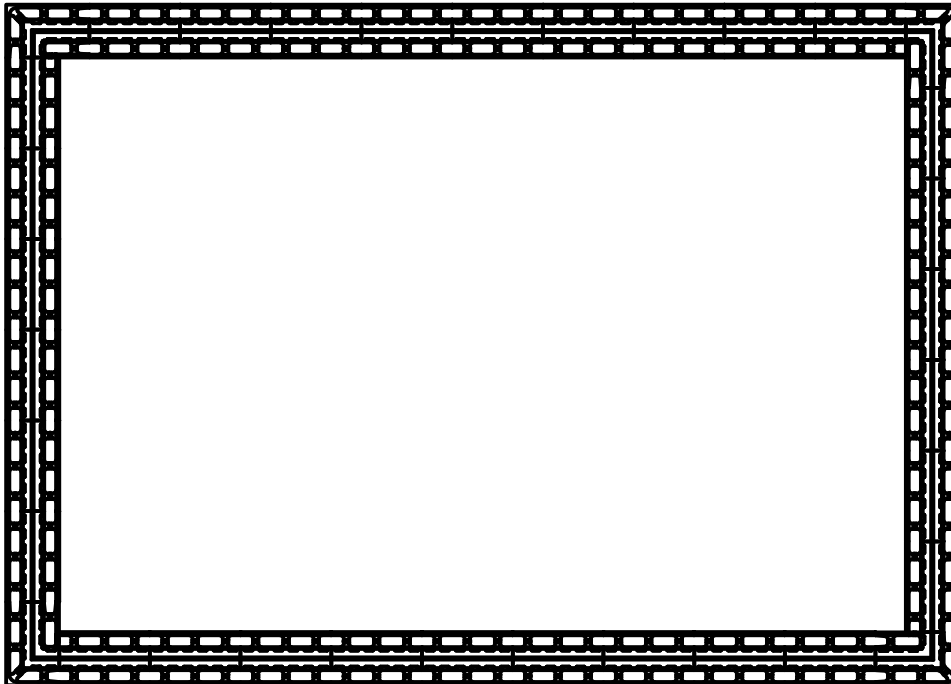

MH-150 MUOTTIHARKKOJEN LADONTA 1.KERROS

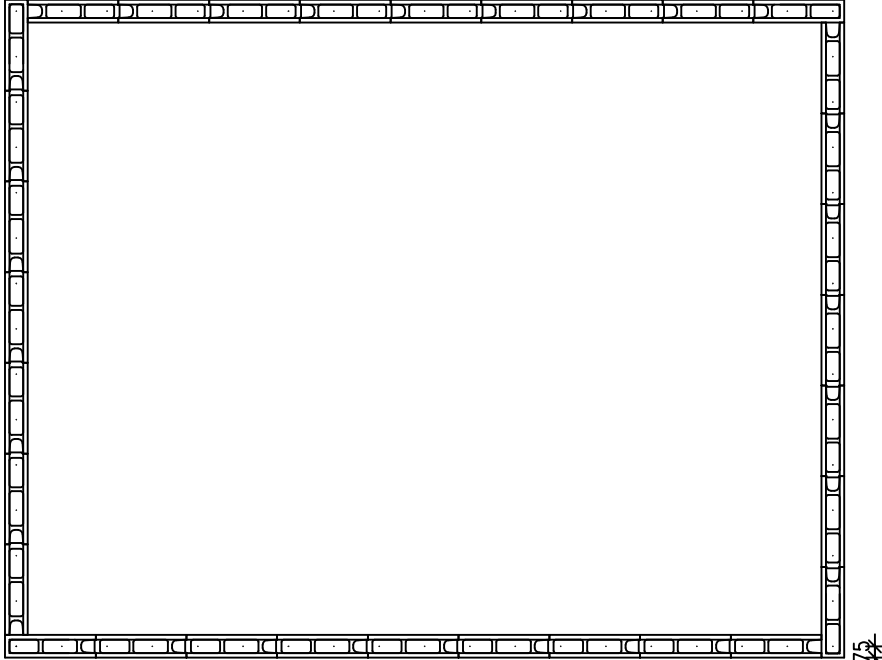

Pystyraudoitukset $\times 300, 300 \times 75$

MH-150 MUOTTIHARKKOJEN LADONTA 2.KERROS

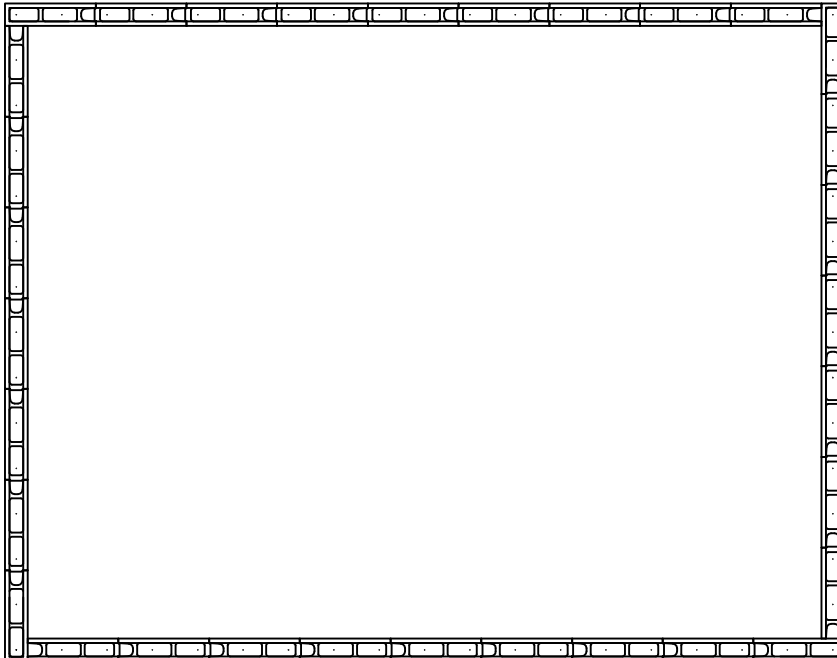

PYSTYTERÄKSIEN JAKO k/k 300 tai 600
 RAUDOITUKSET MÄÄRITTELEE RAKENNESUUNNITTELIJA TAPAUSKOHTAISESTI

PYSTYTERÄKSIEN SIJAINTI MH-150

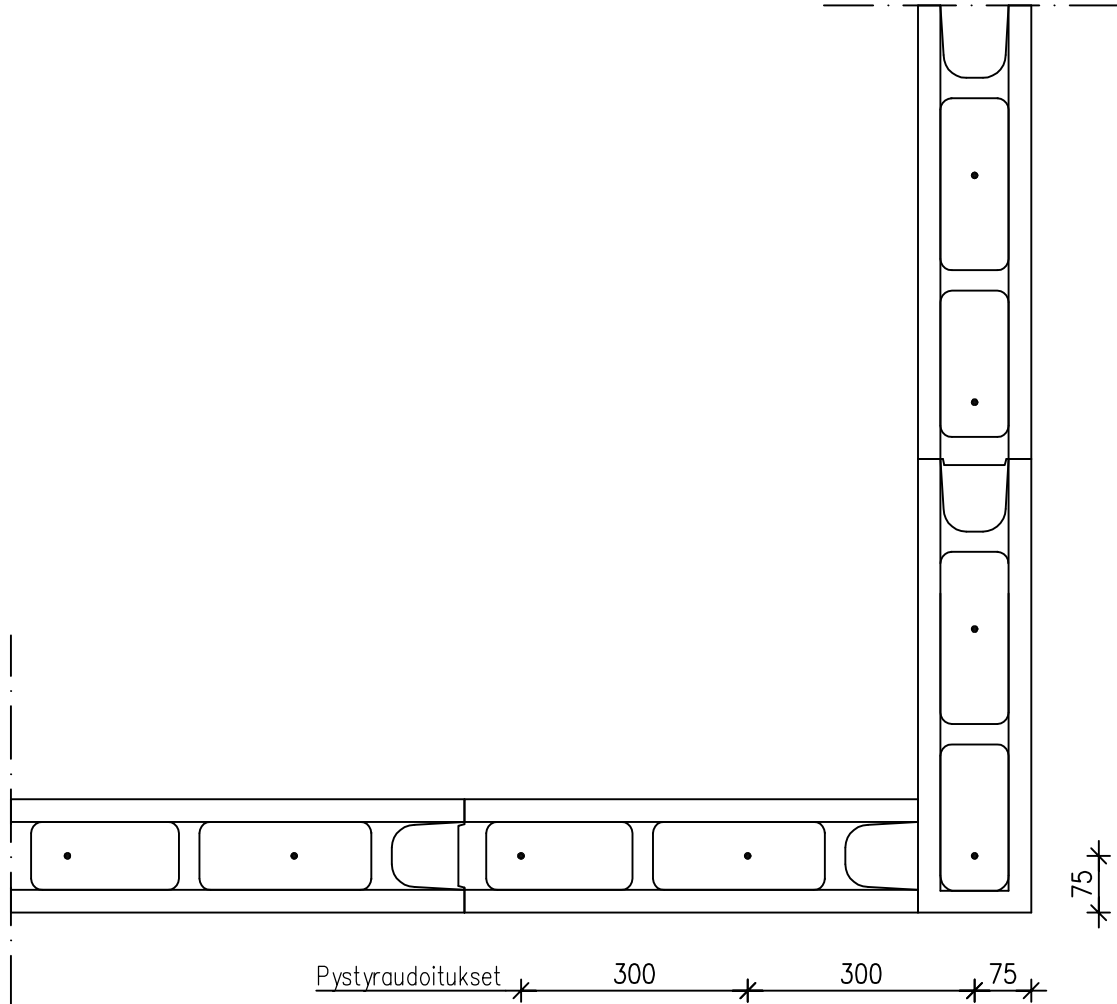

PYSTYTERÄKSIEN JAKO k/k 300 tai 600
 RAUDOITUKSET MÄÄRITTELEE RAKENNESUUNNITTELIJA TAPAUSKOHTAISESTI

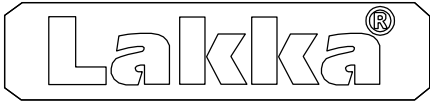

Muottiharkot, Ladonta

RAK, 1:50

LAKKA MH-200

11.10.2016

MH-200 MUOTTIHARKKOJEN LADONTA 1.KERROS

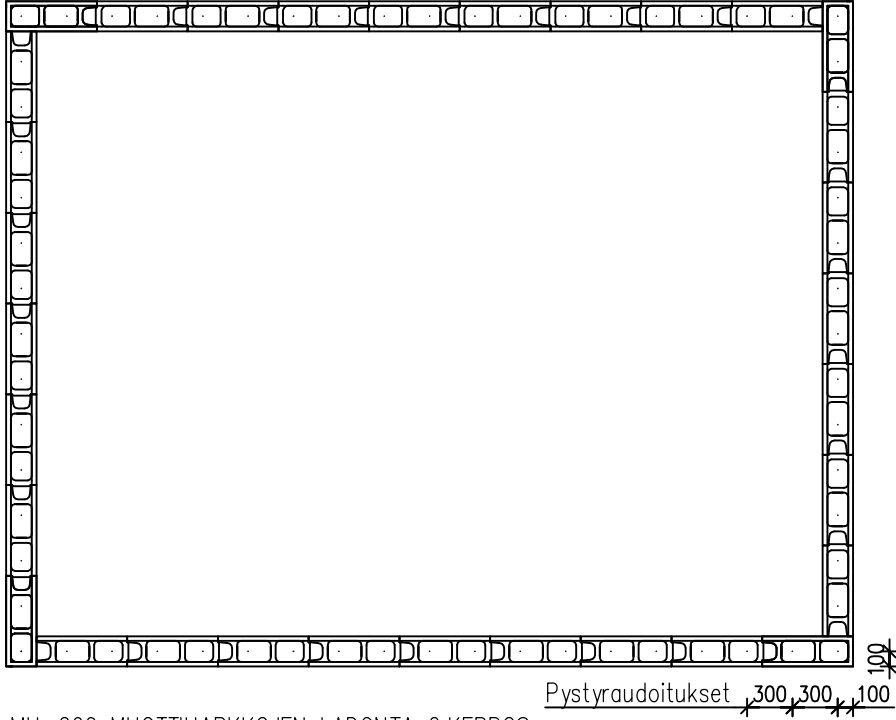

MH-200 MUOTTIHARKKOJEN LADONTA 2.KERROS

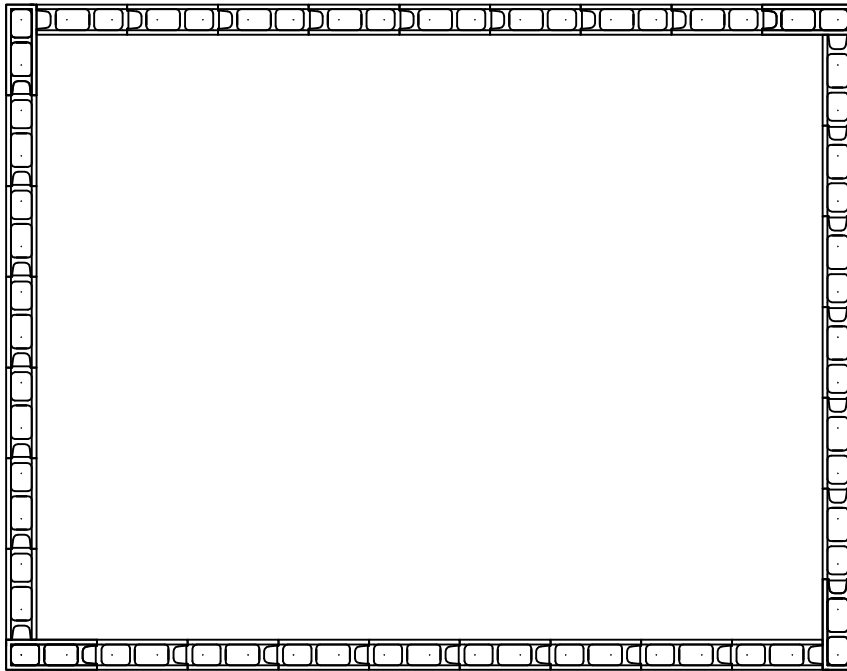

PYSTYTERÄKSIEN JAKO k/k 300 tai 600
RAUDOITUKSET MÄÄRITTELEE RAKENNESUUNNITTELIJA TAPAUSKOHTAISESTI

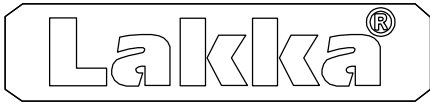

Muottiharkot, Nurkan pystyteräksien sijainti ja päätyharkon käyttö suoralla seinällä

RAK, 1:10

LAKKA MH-200

11.10.2016

PYSTYTERÄKSIEN SIJAINTI MH-200

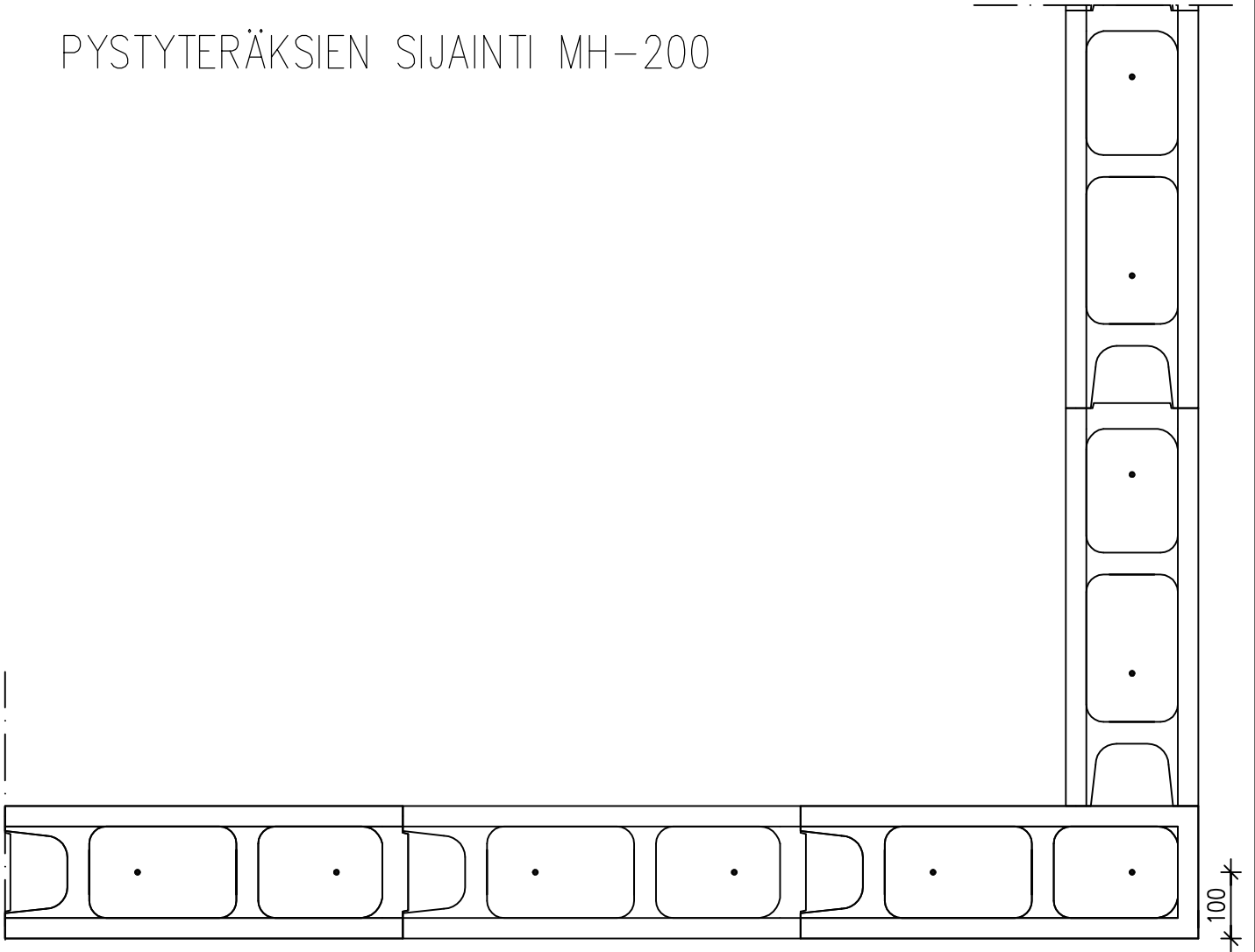

Pystyraudoitukset * 300 * 300 * 100 *

PYSTYTERÄKSIEN JAKO k/k 300 tai 600

RAUDOITUKSET MÄÄRITTELEE RAKENNESUUNNITTELIJA TAPAUSKOHTAISESTI

PÄÄTYHARKON KÄYTTÖ SUORALLA SEINÄLLÄ

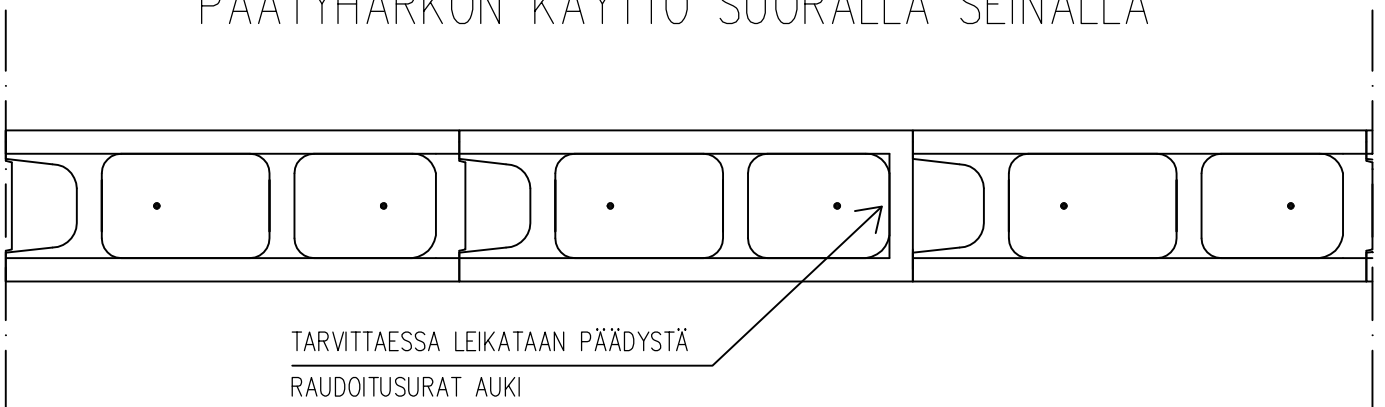

TARVITTAESSA LEIKATAAN PÄÄDYSTÄ

RAUDOITUSURAT AUKI

MH-250 MUOTTIHARKKOJEN LADONTA 1.KERROS

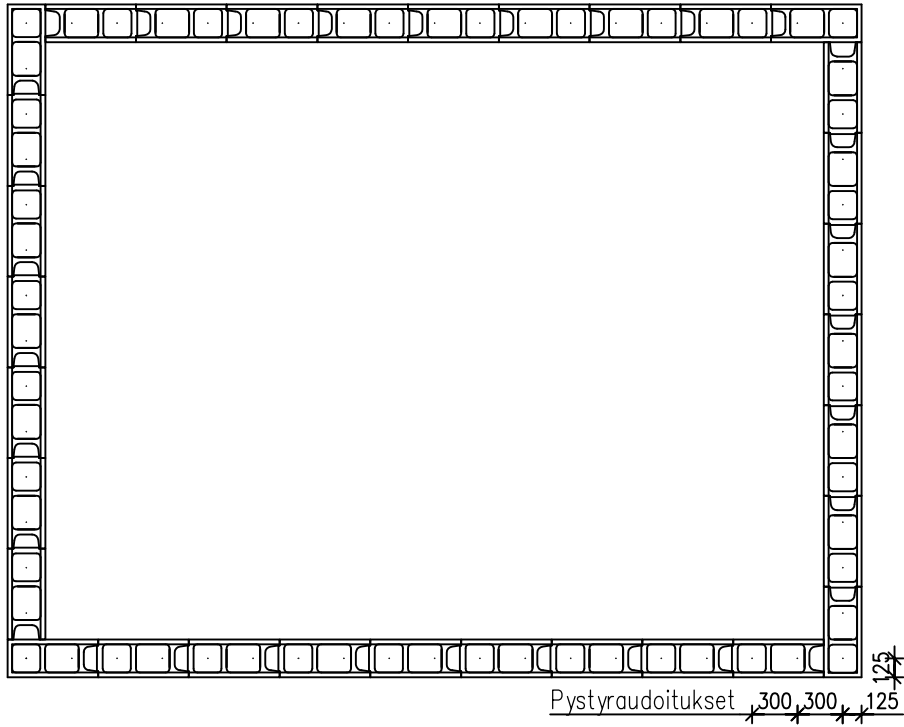

MH-250 MUOTTIHARKKOJEN LADONTA 2.KERROS

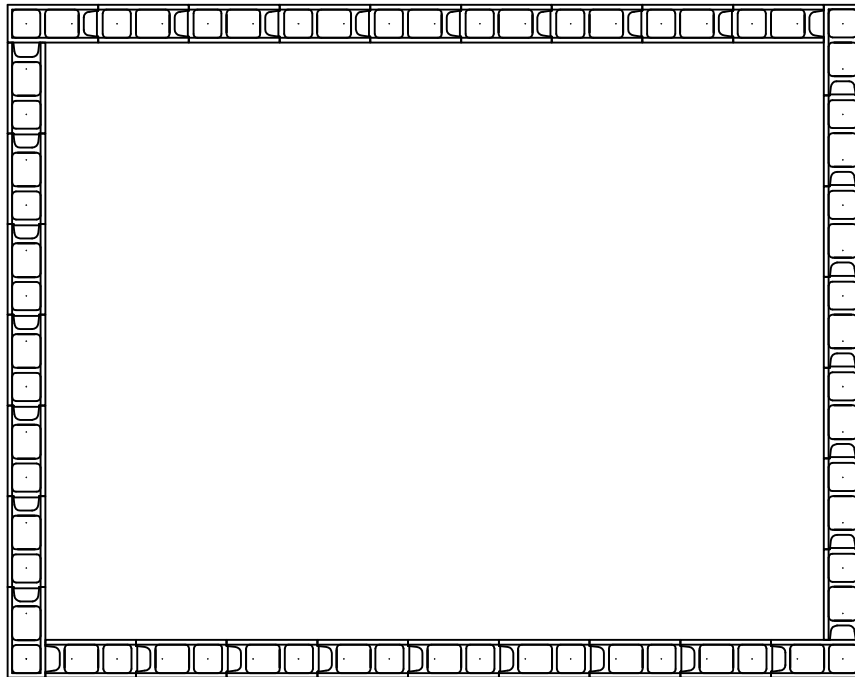

PYSTYTERÄKSIEN JAKO k/k 300 tai 600
 RAUDOITUKSET MÄÄRITTELEE RAKENNESUUNNITTELIJA TAPAUSKOHTAISESTI

PYSTYTERÄKSIEN SIJAINTI MH-250

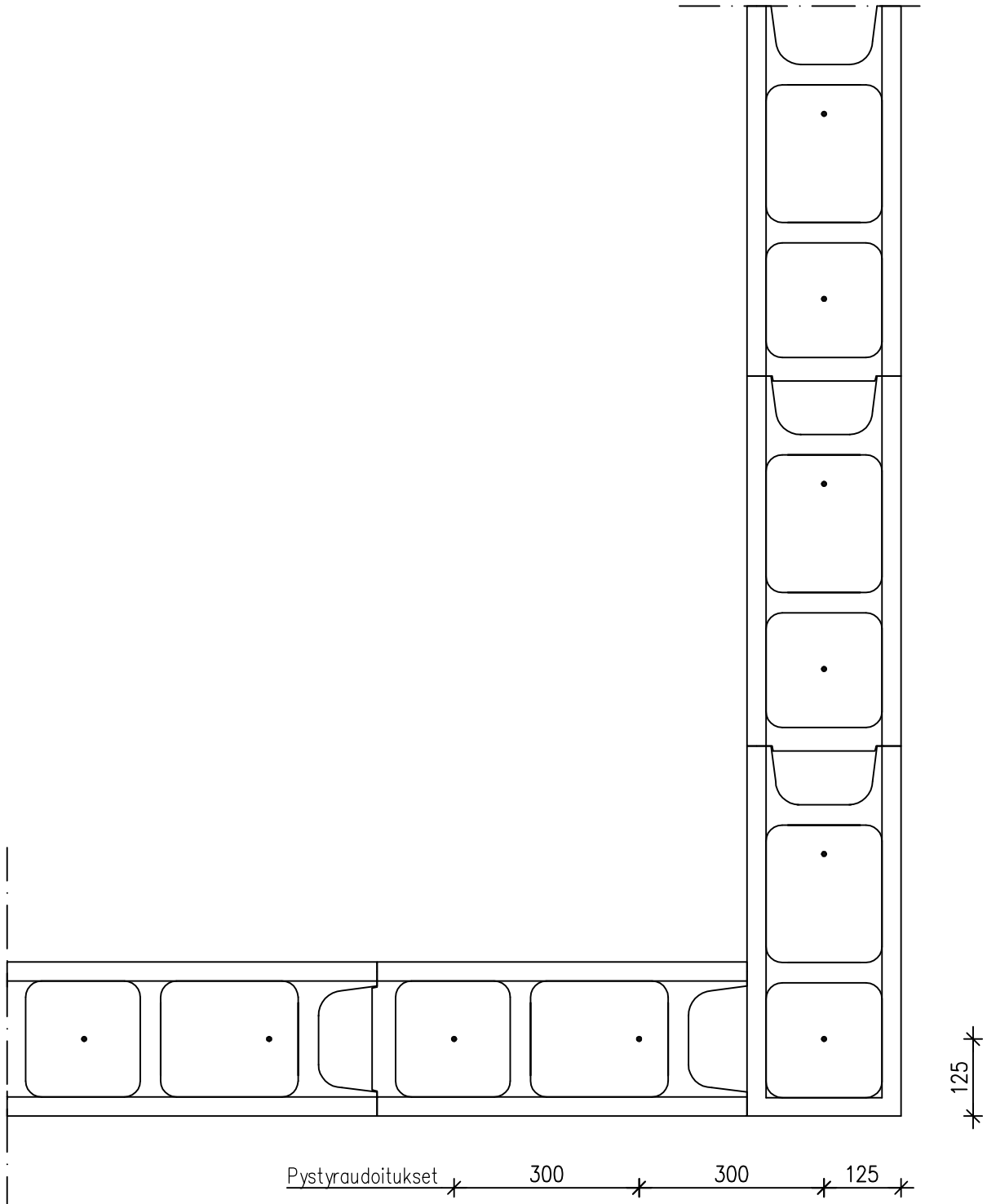

PYSTYTERÄKSIEN JAKO k/k 300 tai 600
 RAUDOITUKSET MÄÄRITTELEE RAKENNESUUNNITTELIJA TAPAUSKOHTAISESTI

MH-200

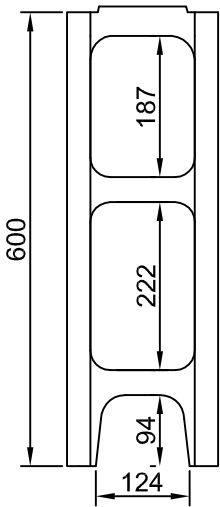
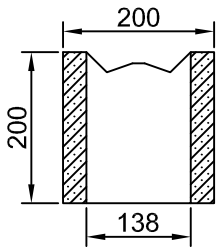

MH-200
PÄÄTYHARKKO

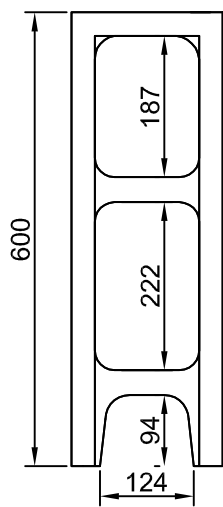
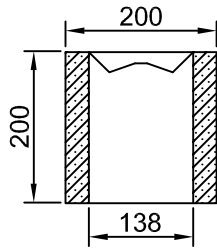

MH-150

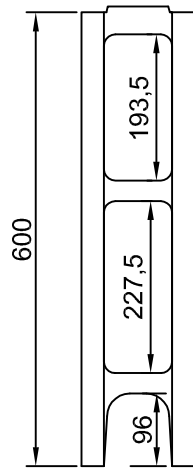
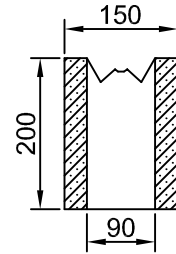

MH-150
PÄÄTYHARKKO

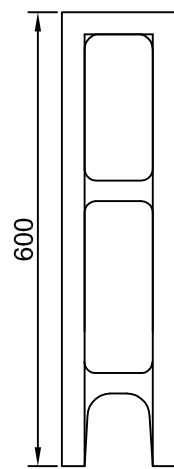
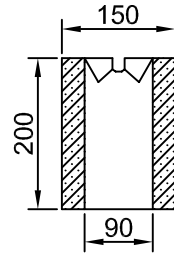

MH-250

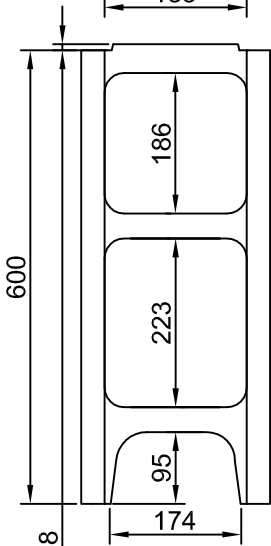
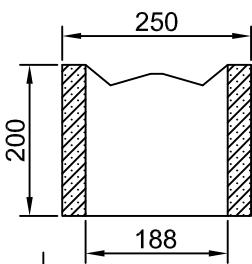

MH-250
PÄÄTYHARKKO

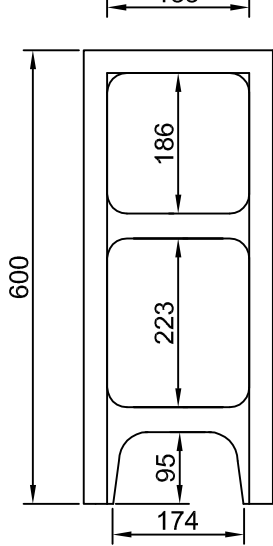
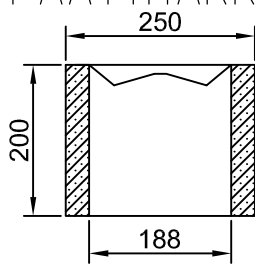

MH-300

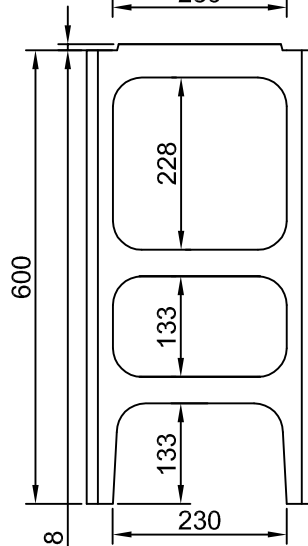
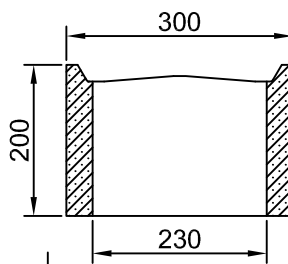

MH-300
PÄÄTYHARKKO

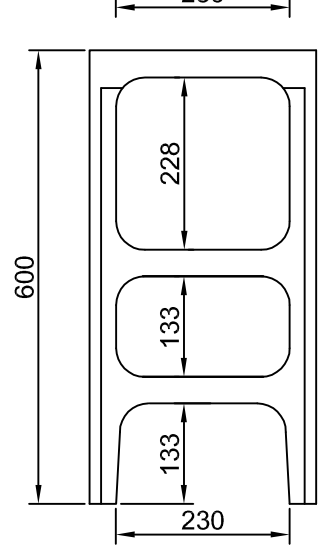
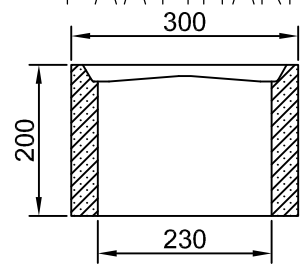

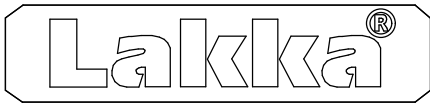

MUOTTIHARKKOJEN MITOITUS

LAKKA MUOTTIHARKOT

26.05.2017

EMH-400PRO

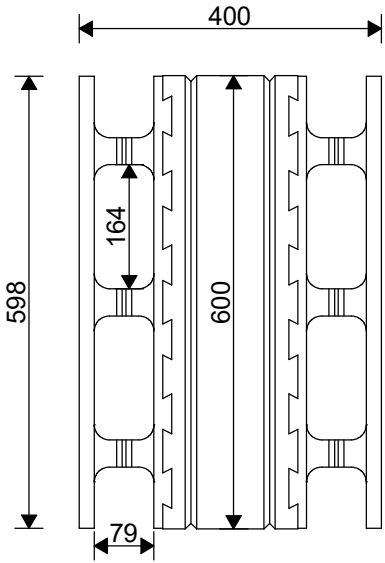

EMH-400PRO KULMA

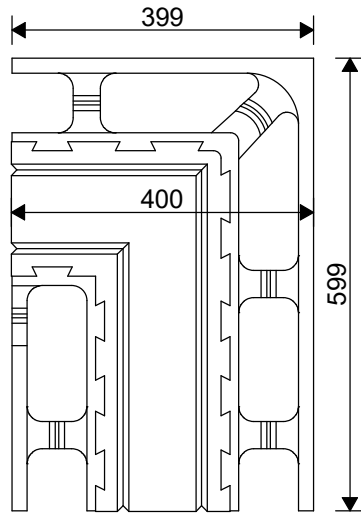

EMH-400PRO PÄÄTY

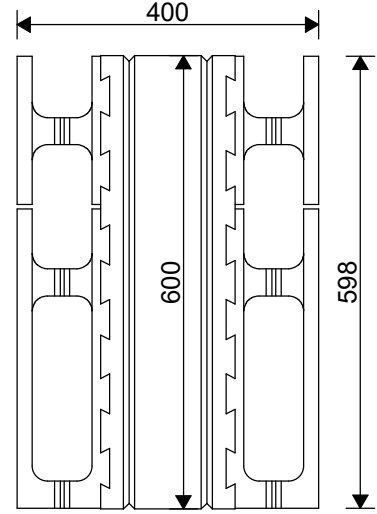

EMH-350PRO

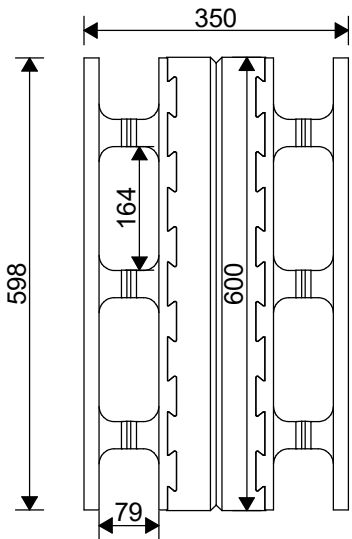

EMH-350PRO KULMA

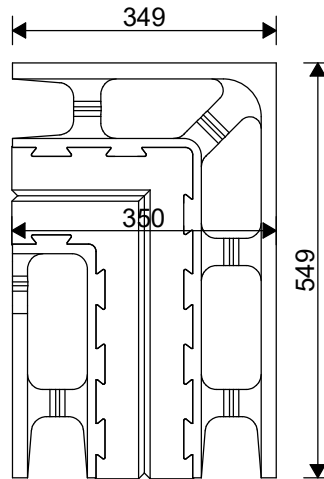

EMH-350PRO PÄÄTY

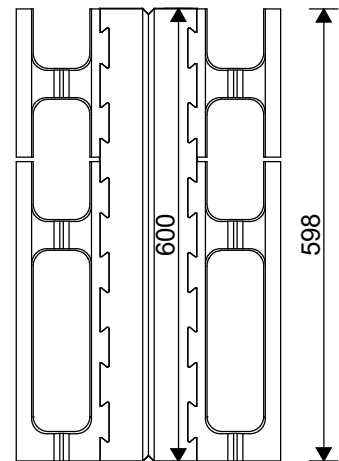

PMH-250

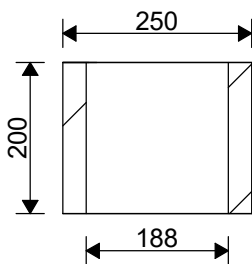

ANT-600

